

WaBack® Access Technical Specification [DN 160 mm]

Model no.:	WB160-WA425
Nominal Size:	160 mm
Material	
Manhole:	PE
Membrane:	
Float:	PE
O-ring:	EPDM
Bracket:	Marine grade stainless steel (AISI 304)
Rubber joint:	EPDM
Plate:	PVC
Fasteners:	Stainless steel (AISI 316)
Foam seal:	PE-foam
Damper:	EPDM/304
Bracket:	Marine grade stainless steel (AISI 304)
Stainless steel frame:	EN1.4301

Technical data:	WB160-WA425
Max back pressure	5 mH ₂ O
Manhole size	425
Riser	

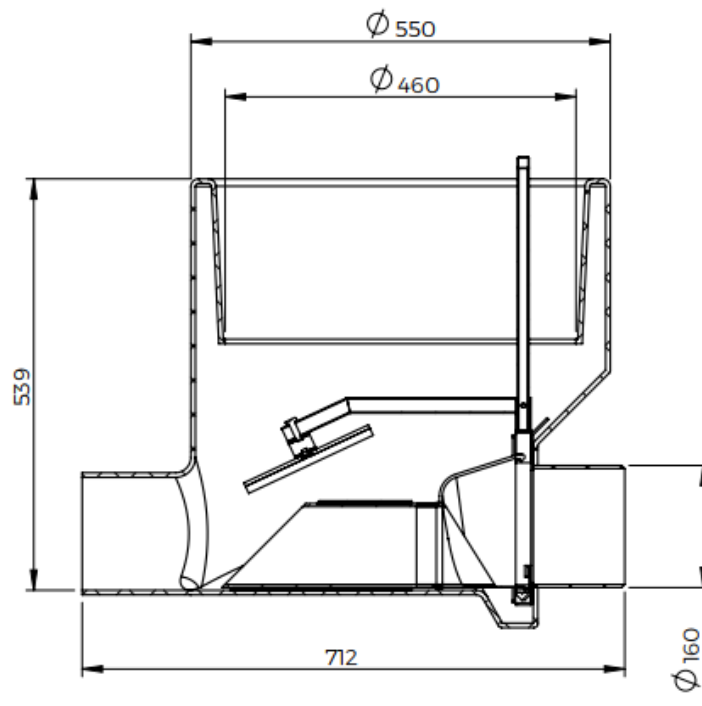

*) +/- 15%

- Values measured from bottom of pipe.

- Tests performed at room temperature (16-20°C). No pipe connected downstream