

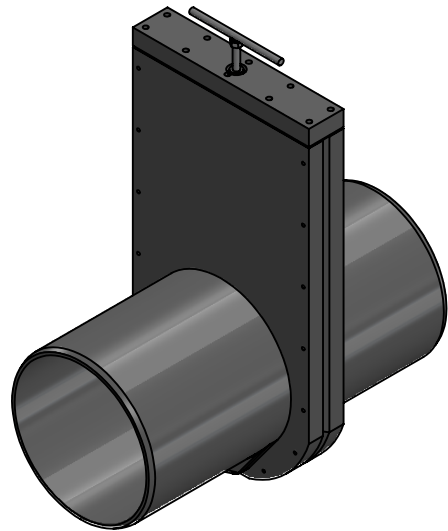

Rev	Note	CreatedBy	Appr.By	Appr.Date
A	Initial release	FG	PW	2020-08-11

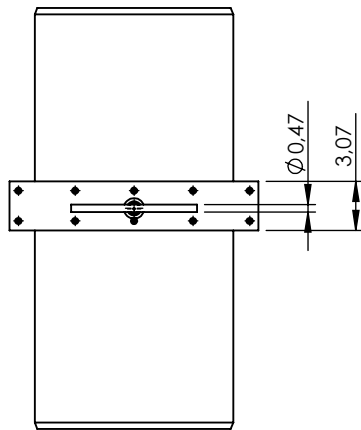
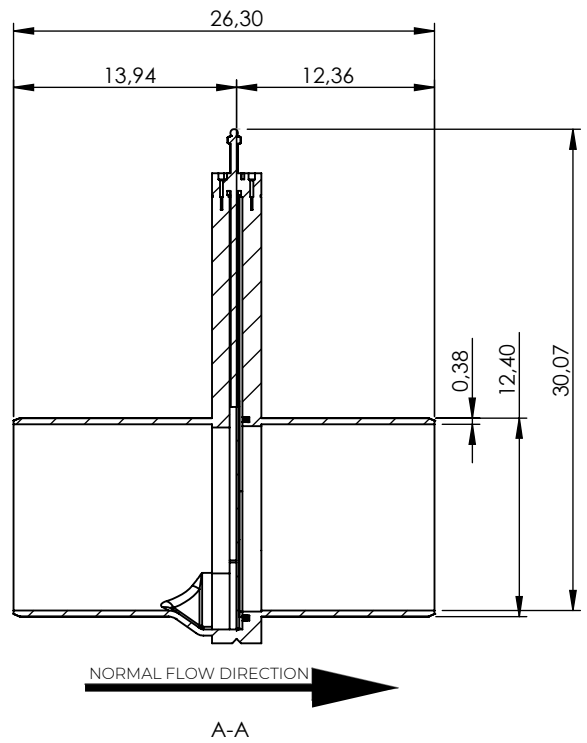
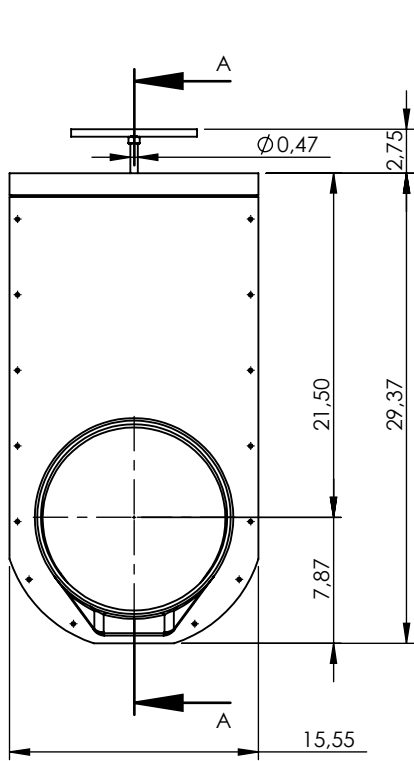
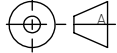

© 2018 Wapro AB. This document is subject to copyrights owned by Wapro AB. Any amendments, republication, retransmission, and/or reproduction of all or any part of the document is expressly prohibited, unless the copyright owner of the material has expressly granted its prior written consent. All other rights are reserved.

Designed By FG	Approved By PW	Created Date 2020-08-10	Units [inch]	General Tolerance SS-ISO 2768-1 m	Scale 1:12	
Material AISI 316L / EN1.4404			Project		Comments	
Weight [Lbs] 42.5		Box Volume [ft ³]	Description WaGate SVL NPS 12" Maximum pressure 14.5 psi			
 www.wapro.com			Article Number W13076315	Drawing Number svl nps12-us	Rev A	Sheet 1 (1)